

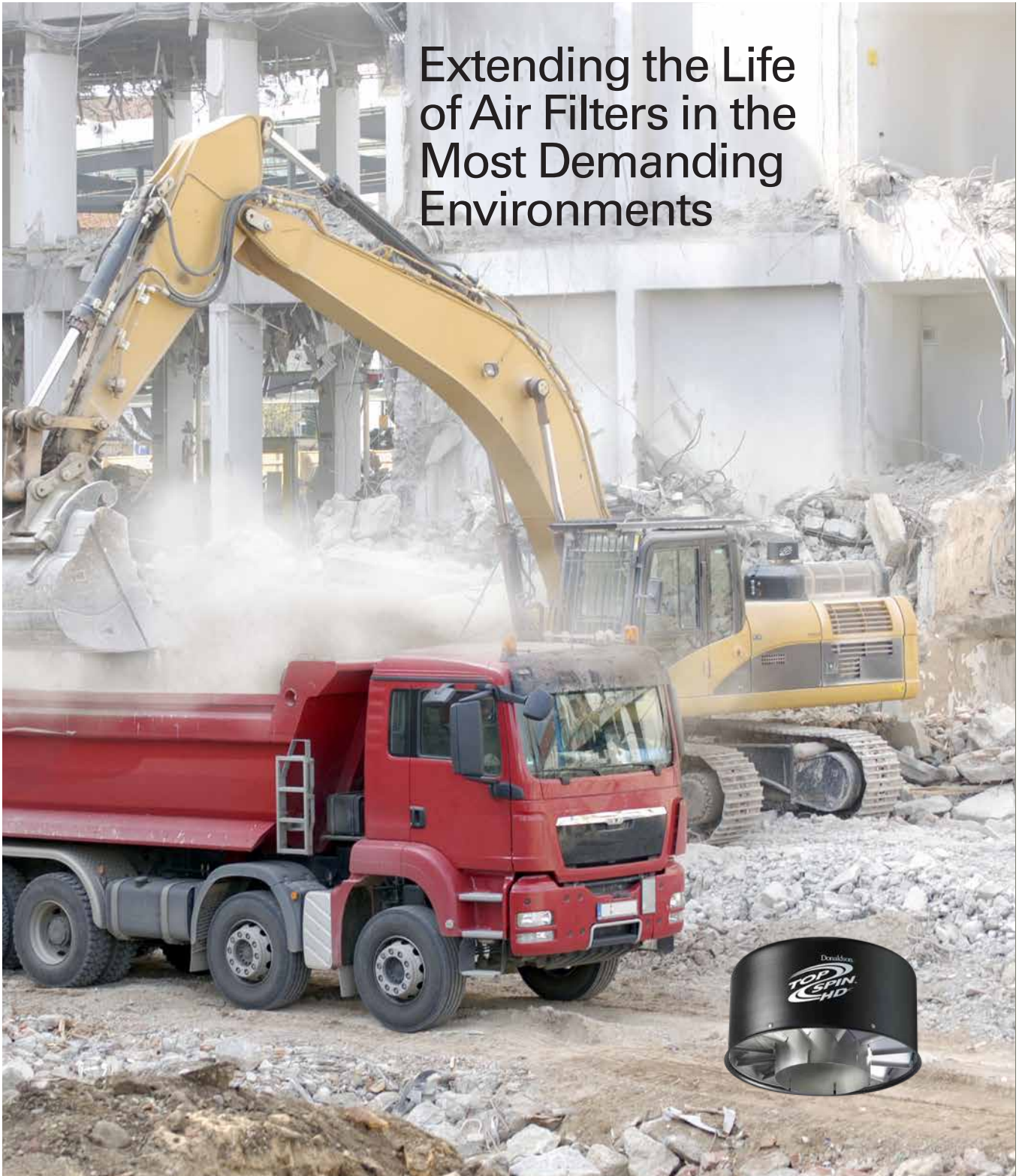

TopSpin™ HD Heavy-Duty Pre-Cleaner

Extending the Life
of Air Filters in the
Most Demanding
Environments



Making air filters work better and last longer. **Whatever you throw at them.**



If dust, grit and dirt are a part of your daily operation, don't make your air cleaners do the job alone. Pre-cleaning the air entering the intake port can dramatically improve the life of air cleaners, and help avoid costly engine failure.

TopSpin™ HD air pre-cleaners are a tough, durable solution for the punishing conditions that can damage exposed equipment.



Available in eight sizes for every engine and airflow level.

Donaldson.



Construction
Mining
Oil & Gas
Quarrying
Logging
Road and Rail
Maintenance
Agriculture

and anywhere
your equipment
encounters heavy
dust and flying debris.

TopSpin™ HD air pre-cleaners separate and eject up to 80%* of incoming contaminants before they can reach the engine's air filter, resulting in:

Longer filter life, less frequent replacement.

Lower operating cost.

Less maintenance time.

In punishing environments like mining, oil and gas, and construction, exposed accessories like pre-cleaners can really take a beating. That's why Donaldson's TopSpin HD may be the last pre-cleaner you'll need to buy. Its all-metal construction, high-efficiency design and low restriction will eject the heaviest dust particles and keep functioning smoothly for as long as you own your machinery.

Best of all there's no bowl to empty. The self-aspirating design means contaminants are continuously purged automatically. Just install a TopSpin HD pre-cleaner and forget about it.

Built as tough as your equipment

Rugged one-piece **aluminum hood** with recessed discharge louver sheds flying debris.

One-piece **stainless steel impeller** is the only moving part. Dual bearings ensure reliable performance.



All the interior components are solid stainless steel to resist dirt, water, heat and abuse.

Stainless steel clamp with locking nut makes installation quick and secure. Clamp is included with each TopSpin HD.



*ISO 5011 with coarse dust

TopSpin HD air pre-cleaners are available in eight sizes, so you can choose one that is appropriate for your airflow requirements.

Your engines will breathe easier.

You'll use far fewer air filters.

You'll operate at lower cost, with less maintenance downtime.

TopSpin HD Performance Curves

Operating Flow Range Airflow (m3/min)

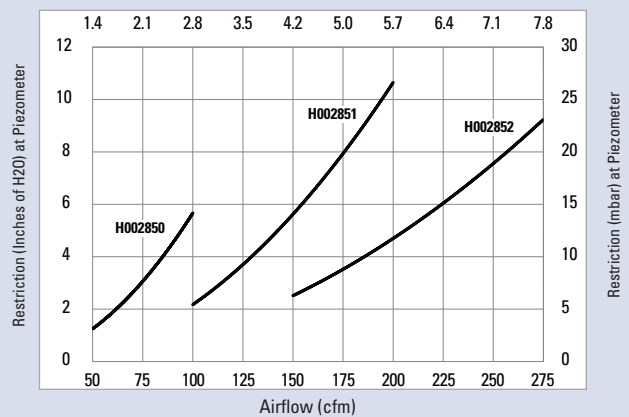

Operating Flow Range Airflow (m3/min)

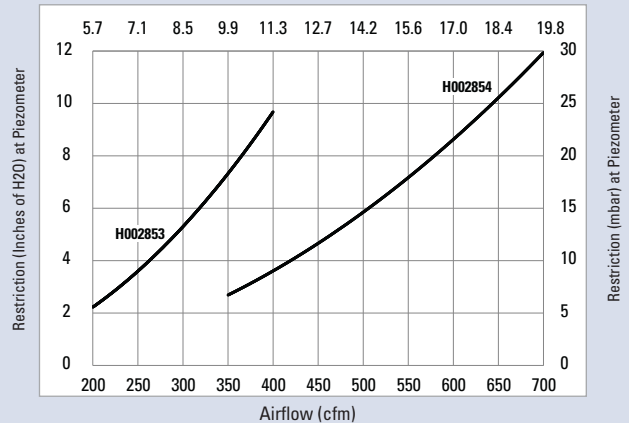

Operating Flow Range Airflow (m3/min)

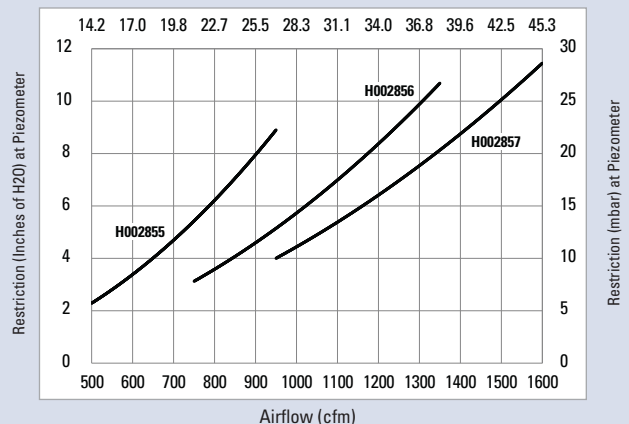

Dimensional Specifications & Order Information





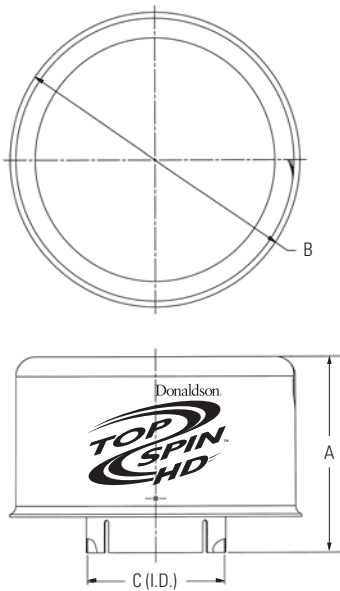



Donaldson TopSpin™ HD pre-cleaners can be mounted in an upright position or horizontally with louver opening at the bottom. Installation instructions and stainless steel locking clamp are included. Limited Lifetime Warranty.

Operating temperature range: -40°F to 180°F (-40°C - 82°C)



IMPORTANT

Mount on metal inlet tube only. Do not mount on plastic inlet tube.

Part Number & Image	Outlet I.D. (C)		Overall Height (A)		Body Dia. (B)		Operating Flow Range		Weight	
	in.	mm	in.	mm	in.	mm	SCFM*	m³/min	lbs.	kg.
H002850 	2.06	52.3	3.41	86.5	5.40	137.2	50-100	1.4-2.8	1.00	0.5
H002851 	2.58	65.5	4.25	108.0	6.30	160.0	100-200	2.8-5.6	1.75	0.8
H002852 	3.07	78.0	4.96	125.9	7.20	182.9	150-275	4.2-7.8	2.75	1.2
H002853 	4.10	104.1	5.81	147.6	8.72	221.6	200-400	5.6-11.3	3.75	1.7
H002854 	5.08	129.0	7.56	192.1	11.19	284.2	350-700	10.0-20.0	6.50	3.0
H002855 	6.10	154.9	7.72	196.0	12.78	324.6	500-950	14.0-27.0	7.25	3.3
H002856 	7.10	180.3	8.38	212.7	14.75	374.6	750-1350	21.0-38.0	9.50	4.3
H002857 	8.08	205.2	8.38	212.7	14.75	374.6	950-1600	26.6-44.8	9.50	4.3

*SCFM = Standard Cubic Feet per Minute. The ISO 5011/SAEJ726 test procedure was used to extract the results in the charts above. The ISO 5011/SAEJ726 is a widely accepted industry test used by OEMs to evaluate the efficiency of the intake system components. Test results are an average from testing several units.

If you currently use Donaldson Full-View or TopSpin™ pre-cleaners, find a compatible TopSpin HD heavy-duty pre-cleaner from the chart below.

It's Easy to Switch

Find a compatible Donaldson TopSpin HD heavy-duty pre-cleaner to replace any of the models listed here.



COMPETITIVE CROSS-REFERENCE

Donaldson TopSpin HD	Centri	Enginaire	Fleetguard	Sy-Klone	Turbo II	Turbo III
H002850	EX-20	200	AP8408 / AP3000	9000R		15
H002851	EX-25	255	AP3000			
H002852	EX-30	330	AP3000		24	50
H002853	EX-40	440S	AP8403 / AP4500	9001R	24	50
H002854	EX-50	550	AP8404 / AP5000	9002/9002R	46	
H002855	EX-60	660			68	500
H002856	EX-70	770L	AP8405	9003	68	500
H002857	EX-80	880			68	500

Donaldson Full-View	Donaldson TopSpin™	Donaldson TopSpin HD
H001823	H002434	H002850
H001251	H002436	H002851
H001249	H002437	H002852
H000858	H002394	H002853
H002043	H002433	H002854
H002223	H002438	H002855
H002224	H002439	H002856
N/A	N/A	H002857



Donaldson Company, Inc.
Minneapolis, MN

donaldson.com
shop.donaldson.com

North America 800-374-1374
Mexico, Latin America, & Caribbean 52-449-300-2400
Brazil 55-11-4894-6339
Europe 32-16-38-3811
South Africa 27-11-997-6000

Southeast Asia 65-6311-7373
Greater China 86-400-650-0610
Japan 81-42-540-4112
Korea 82-2-517-3333
Australasia 61-02-4350-2033
India 91-124-4807-400

Brochure No. F111382 ENG (5/18)

© 2018 Donaldson Company, Inc. All rights reserved. Donaldson Company, Inc. reserves the right to change or discontinue any model or specification at any time and without notice. Printed in the U.S.A.