



**PowerCore®**  
A Donaldson Filtration Technology

**PowerCore®  
air cleaners deliver . . .**

- System design flexibility
- Metal-free, lightweight materials
- Rugged construction
- Straight-through airflow technology invented by Donaldson
- RadialSeal™ advanced sealing technology
- Ideal for light dust environments
- Connect the PCD to an external pre-cleaner for medium to heavy dust environments (see page 189 for external pre-cleaner options).

The PCD air cleaner family offers single-stage filtration in a single, compact unit that delivers superior filtration performance using our PowerCore Filtration Technology.



**PowerCore® Straight-Through Airflow Schematic**

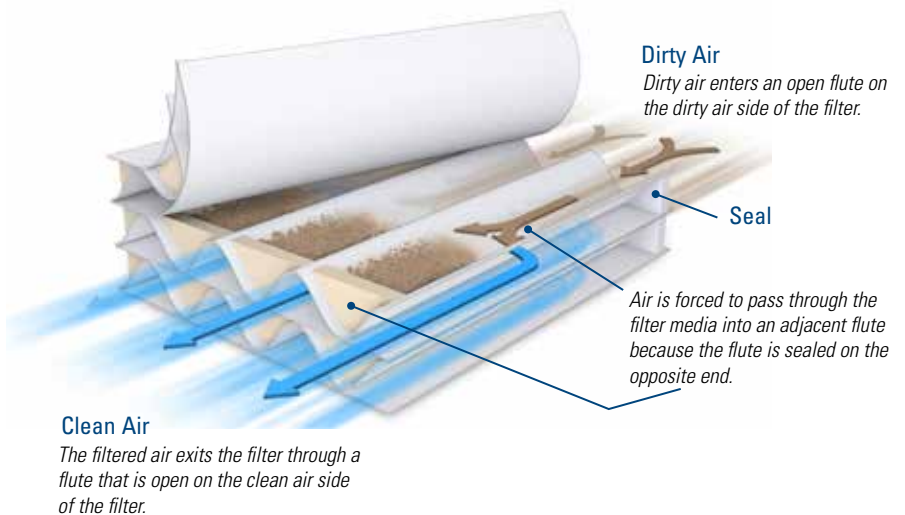

**Big Performance, Small Footprint**

**PowerCore air filters are up to 65% smaller than a conventional RadialSeal™ filter.**



## PCD PowerCore Air Cleaner is Ideal for Light Dust Environments



**PowerCore®**  
A Donaldson Filtration Technology

This air cleaner family offers single-stage filtration in a compact unit that delivers superior filtration performance using our PowerCore® Filtration Technology.

This non-metal air cleaner (except for cover clamps) is ideal for equipment operating in light dust environments.

### Applications

- Light dust conditions with engine airflow ranges up to 974 cfm.
- Obround housing shape allows for a narrow or wide mounting orientation
- Models have side filter service access
- Sustained temperature tolerance: -40 °F to 180 °F / -40 °C to 82 °C

### Features

- More compact at a given performance level than standard pleated filters
- Non-metal filters
- Improved engine protection: no media movement, expansion, contraction or bunching
- Improved contaminant encapsulation: dust and dirt stay contained in filter during service
- Improved handling and maintenance: lighter and smaller
- Easily serviced; no tools required to remove or replace cover, changing filters is a snap
- Built in mounting brackets eliminate the need to purchase separate mounting bands
- Available with either inline inlet/outlet or offset inlet/outlet (see images on next page)

### PCD09, PCD10

Exploded view of D090283



*Easy Service. The filter can be easily removed with the built-in grab handle.*

## Excellent Performance in Half the Space

### Inlet/outlet orientation

D090283 Offset Inlet/Outlet



D090282 Inline Inlet/Outlet



### Mounting Flexibility

With mounting locations on three sides of the housing, the PCD series offers a great deal of flexibility for a wide variety of installations.



U-clips are shipped with each air cleaner. Affix these to the mounting location (all in the same direction) and slide the housing into place. See dimensional illustration for u-clip mounting hole pattern on page 50.

The PCD air cleaner needs to be mounted to equipment on at least one mounting location (base, or either of two sides). It can also be mounted at two points, using the base and one side. It should not be mounted using the two side mounting locations as this will cause pressure/flexing, and could result in leaks. See illustration, on right. The Xs represent u-clips mounted on both sides adjacent to the access cover. The u-clips accept M8 threaded fasteners. Maximum torque is 18 N•m.

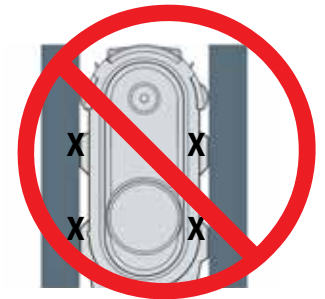

### Mounting Orientation Guidelines

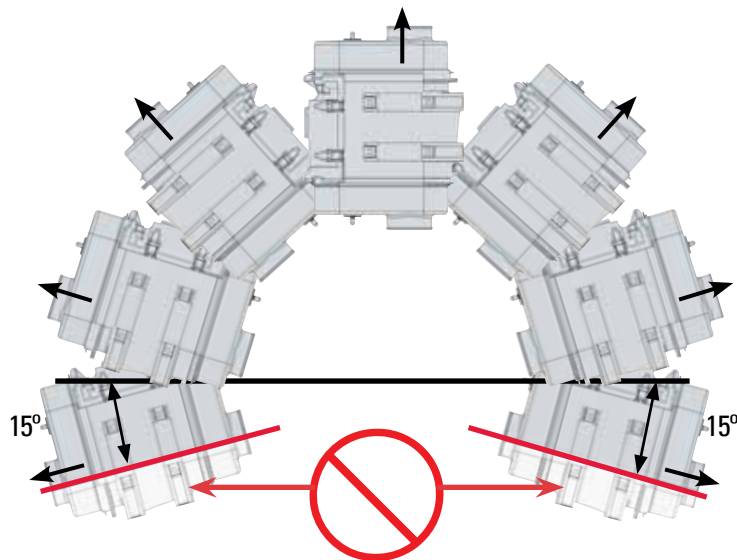

Outlet Position Side View

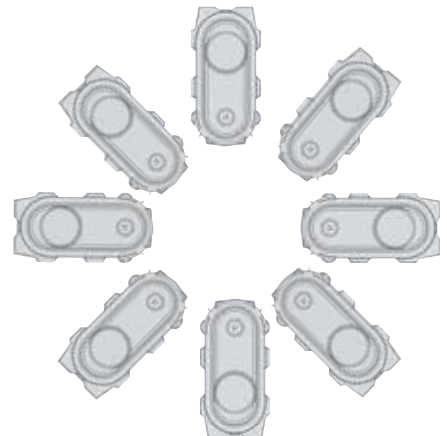

Outlet Position Front View  
Any Orientation is Acceptable



**CAUTION: Outlet Tube Mounting Position**

The outlet tube angled 15° below the horizontal axis could allow dust or foreign objects to fall into the air duct or engine during servicing.



### When Selecting an Air Cleaner . . .

Determine the airflow requirements of your engine, then find the corresponding cfm airflow in the table below. The restriction numbers (shown in inches of water) indicate the approximate initial restriction of each model air cleaner at that cfm. If there are two air cleaner models that fit your parameters, choosing the one with the lower restriction will provide longer filter service life. When calculating total initial restriction of the entire air intake system, include the restriction caused by ducting, elbows, and pre-cleaners. See pages 271-272 for ducting restriction estimates.

### Initial Airflow Restriction

CFM @ "H <sub>2</sub> O	CFM @ "H <sub>2</sub> O			Air Cleaner Model
	6"	8"	10"	
416	487	550		D090283
416	487	550		D090282
422	493	555		D090271
422	493	555		D090270
725	848	956		D100395
725	848	956		D100394
746	867	974		D100388
746	867	974		D100387



PCD Offset Inlet/Outlet Options

### PCD Air Cleaner Performance Curves\*

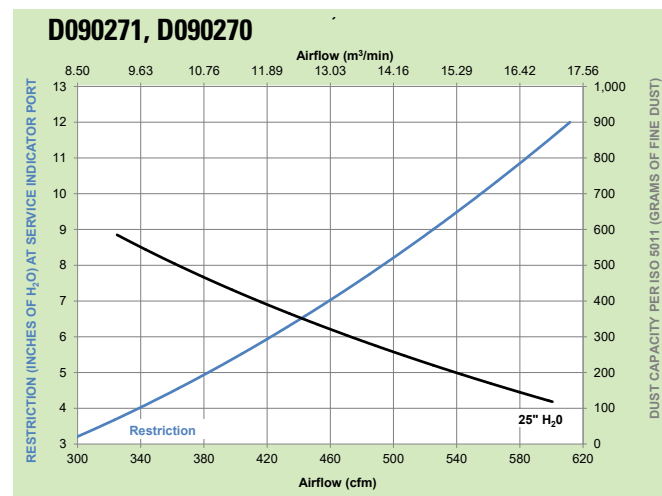
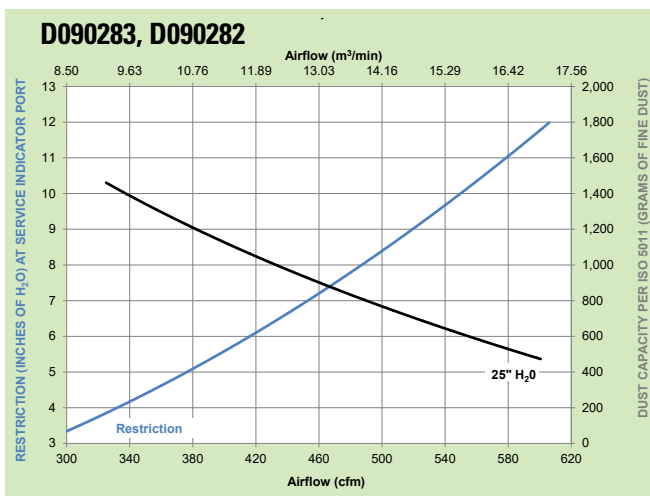

\*Results generated using laboratory testing pursuant to ISO5011. Actual performance during use may vary depending on multiple factors, including specific product configuration, external conditions and application.



continued — PCD Air Cleaner Performance Curves

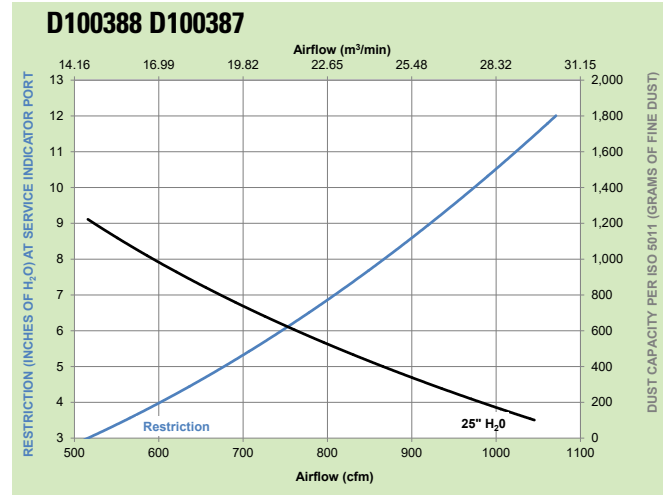
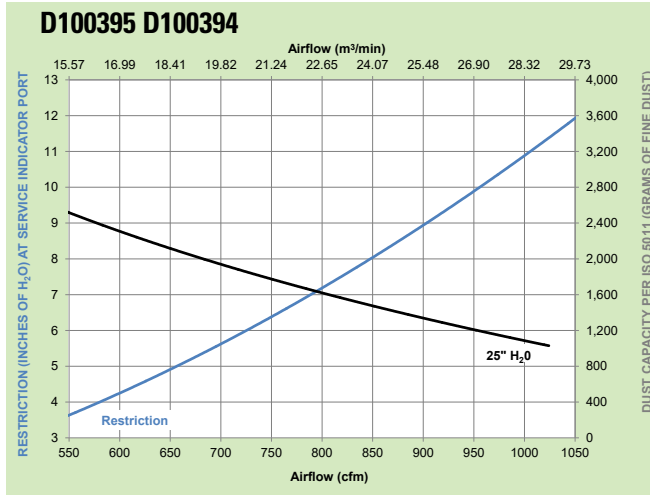

**Service Parts & Accessories**

<b>D090271, D090270</b>	<b>PCD</b>
Cover.....	P785651 ...3
Elbow, 45°.....	P105545
Elbow, 90°.....	P105533
Elbow, 90° reducing.....	P121482
Filter, primary.....	P641175 ...3
Filter, safety.....	P606121 ...3
Hump hose.....	P105609
Informer™ indicator 25" H <sub>2</sub> O.....	X002277
Latch.....	P777366 ...3
Outlet band clamp.....	P148343
U-clip (4 clips).....	P784517 ...3

<b>D090283, D090282</b>	<b>PCD</b>
Cover.....	P786989 ...3
Elbow, 45°.....	P105545
Elbow, 90°.....	P105533
Elbow, 90° reducing.....	P121482
Filter, primary.....	P641176 ...3
Filter, safety.....	P606121 ...3
Hump hose.....	P105609
Informer™ indicator 25" H <sub>2</sub> O.....	X002277
Latch.....	P777366 ...3
Outlet band clamp.....	P148343
U-clip (4 clips).....	P784517 ...3

<b>D100388, D100387</b>	<b>PCD</b>
Cover.....	P784279 ...3
Cover, with watertight seal.....	P619481
Elbow, 45°.....	P109021
Elbow, 90°.....	P107844
Elbow, 90° reducing.....	P143895
Filter, primary.....	P957050 ...3
Filter, safety.....	P601560 ...3
Hump hose.....	P105610
Informer™ indicator 25" H <sub>2</sub> O.....	X002277
Latch.....	P777366 ...3
Outlet band clamp.....	P148345
U-clip (4 clips).....	P784517 ...3

<b>D100395, D100394</b>	<b>PCD</b>
Cover.....	P784298 ...3
Cover, with watertight seal.....	P619482
Elbow, 45°.....	P109021
Elbow, 90°.....	P107844
Filter, primary.....	P641172 ...3
Filter, safety.....	P601560 ...3
Hump hose.....	P105610
Informer™ indicator 25" H <sub>2</sub> O.....	X002277
Latch.....	P777366 ...3
Outlet band clamp.....	P148345
U-clip (4 clips).....	P784517 ...3

**NOTES:**  
3 = Shipped with air cleaner initially



PCD09, PCD10

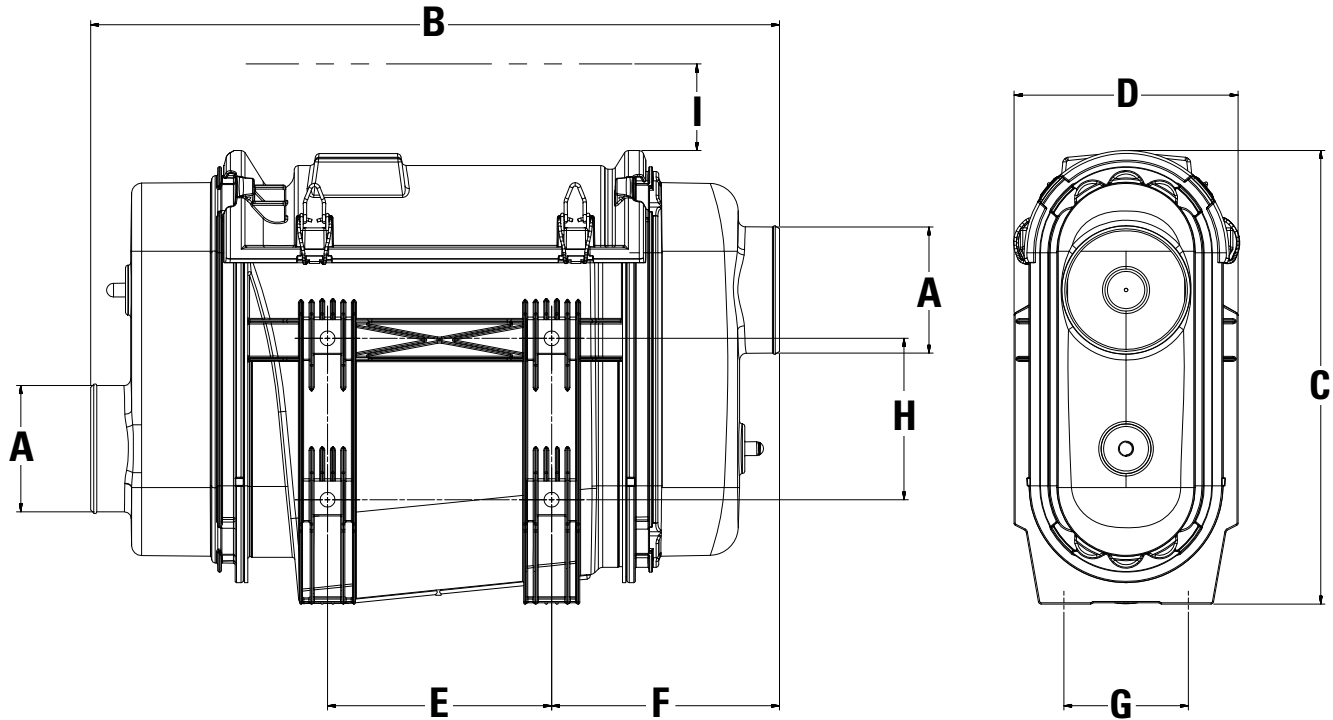

**Note:** a minimum service clearance of 50mm (2.00") is required for wire latches.



## PCD09, PCD10 Specifications (Letters are keyed to drawings)

Inlet Orientation: I=Inline; O=Off-set

Part No. / Orientation	A		B		C		D		E		F		G		H		Service Clearance (I)		Weight	
	mm	in	mm	in	mm	in	mm	in	mm	in	mm	in	mm	in	mm	in	mm	in	kg	lbs
D090283 O	102	4.00	553	21.77	365	14.37	180	7.09	180	7.09	183	7.21	100	3.94	130	5.12	356	14.0	4.8	10.5
D090282 I	102	4.00	553	21.77	365	14.37	180	7.09	180	7.09	183	7.21	100	3.94	130	5.12	356	14.0	4.8	10.5
D090271 O	102	4.00	453	17.85	360	14.18	180	7.09	110	4.33	173	6.83	100	3.94	130	5.12	330	13.0	4.1	9.1
D090270 I	102	4.00	453	17.85	360	14.18	180	7.09	110	4.33	173	7.21	100	3.94	130	5.12	330	13.0	4.1	9.1
D100395 O	127	5.00	536	21.10	384	15.12	254	10.01	210	8.27	165	6.50	110	4.33	110	4.33	356	14.0	5.9	13.0
D100394 I	127	5.00	536	21.10	384	15.12	254	10.01	210	8.27	165	6.50	110	4.33	110	4.33	356	14.0	5.9	13.0
D100388 O	127	5.00	436	17.17	375	14.75	254	10.01	110	4.33	165	6.50	110	4.33	110	4.33	356	14.0	5.2	11.4
D100387 I	127	5.00	436	17.17	375	14.75	254	10.01	110	4.33	165	6.50	110	4.33	110	4.33	356	14.0	5.2	11.4



This servicing information is provided as a best practices guide. It is not intended to replace or supersede the service instructions supplied by your engine or vehicle manufacturer. Note: Your air cleaner service cover may be in a different position than shown.

## 1 Check the Restriction

Replace the filter only when the restriction level has reached the maximum recommended by the engine or equipment manufacturer or on a regular scheduled service.



## 2 Remove the Primary Filter

Push down on the service handle to tilt the filter to a 5° angle. This will loosen the seal. Then, pull up on the service handle to remove the filter from the housing.



## 3 Visually Inspect the Safety Filter

Remove any excess dirt and wipe out the housing with a damp cloth before servicing the safety filter. Visually inspect the safety filter but do not remove it unless it is damaged or due for change-out. Verify that the safety filter is properly seated in the housing. The safety filter should be replaced every three primary filter changes.



*NEVER use a pressure sprayer to clean out the air cleaner housing while it is installed on the machine.*

## 4 Remove Safety Filter if Indicated or if Excessively Contaminated

To remove the safety filter, use the plastic handle on the face of the safety filter. Pull the filter toward the center of the housing and remove it. Ensure that the outlet tube sealing area is clean and undamaged. If the safety filter is removed and the new filter is not to be installed immediately, be sure to cover the seal tube with a cloth so that dirt is not admitted. After removing the safety filter, wipe the air cleaner housing interior and seal surfaces with a clean, damp cloth.



## 5 Inspect the New Filters

Visually check for cuts, tears or indentations on the sealing surfaces and the media pack before installation. If any damage is visible, do not install.



*The safety filter should be replaced every three primary filter changes.*

Continued on next page



### 6 Replace the Safety Filter

If replacing the safety filter, use the plastic handle. Slide the filter at an angle into the outlet side and push it in place until the filter seats firmly and evenly within the housing.



### 7 Insert the Primary Filter

Slide the filter down at approximately a 5° angle until it makes contact with the end of the housing. Rotate the filter toward the outlet section to complete the seal.



### 8 Replace the Service Cover

Place the service cover in position and fasten the metal latches. If the cover doesn't seat, remove and re-check the filter position and access cover orientation.



### 9 Inspect the Entire Air Cleaner System

Make sure that inlet and outlet connections are in good condition. Torque to and do not exceed 40 in•lb. Replace rubber connectors if necessary and reset the service indicator.

