



HDK06

Max Flow: 150 gpm (568 lpm)



HDK06 In-Line/Tank Mount Filters

Working Pressures to:

350 psi / 2415 kPa / 24.1 bar

Rated Static Burst to:

500 psi / 3450 kPa / 34.5 bar

Flow Range To:

150 gpm / 568 lpm

Applications

- Cooling Circuits
- Fluid Conditioning Systems
- Lube Oil Systems
- Return Lines
- Suction Lines

Features

HDK06 filters come in two styles: In-line and tank mount. Both styles feature a die cast aluminum head and steel body for strength and durability; service is made easier with a single, center retention bolt on top of the head. Filter flow is inside to outside. Nitrile seals are standard.

HDK06 assemblies come complete with our $\beta_{9(c)}=1000$ rated Synteq™ filter cartridge. Other ratings are available, depending on your cleanliness requirements. HDK06 comes with an easy-to-read visual service indicator.



In-line model shown

Beta Rating

- Performance to $\beta_{<4(c)}=1000$

Porting Size Options

- 2½" NPT

Replacement Filter Lengths

- 16.00" / 406mm

Standard Bypass Ratings

- 25 psi / 172.5 kPa / 1.7 bar

Assembly Weight

- 39.25 lbs / 18 kg

Operating Temperatures

- -20°F to 250°F
- -29°C to 121°C

Filter Collapse Ratings

- 100 psid / 690 kPa / 6.9 bar

HDK06 Specification Illustrations

ASSEMBLY - SIDE VIEW

All dimensions are shown in inches [millimeters].

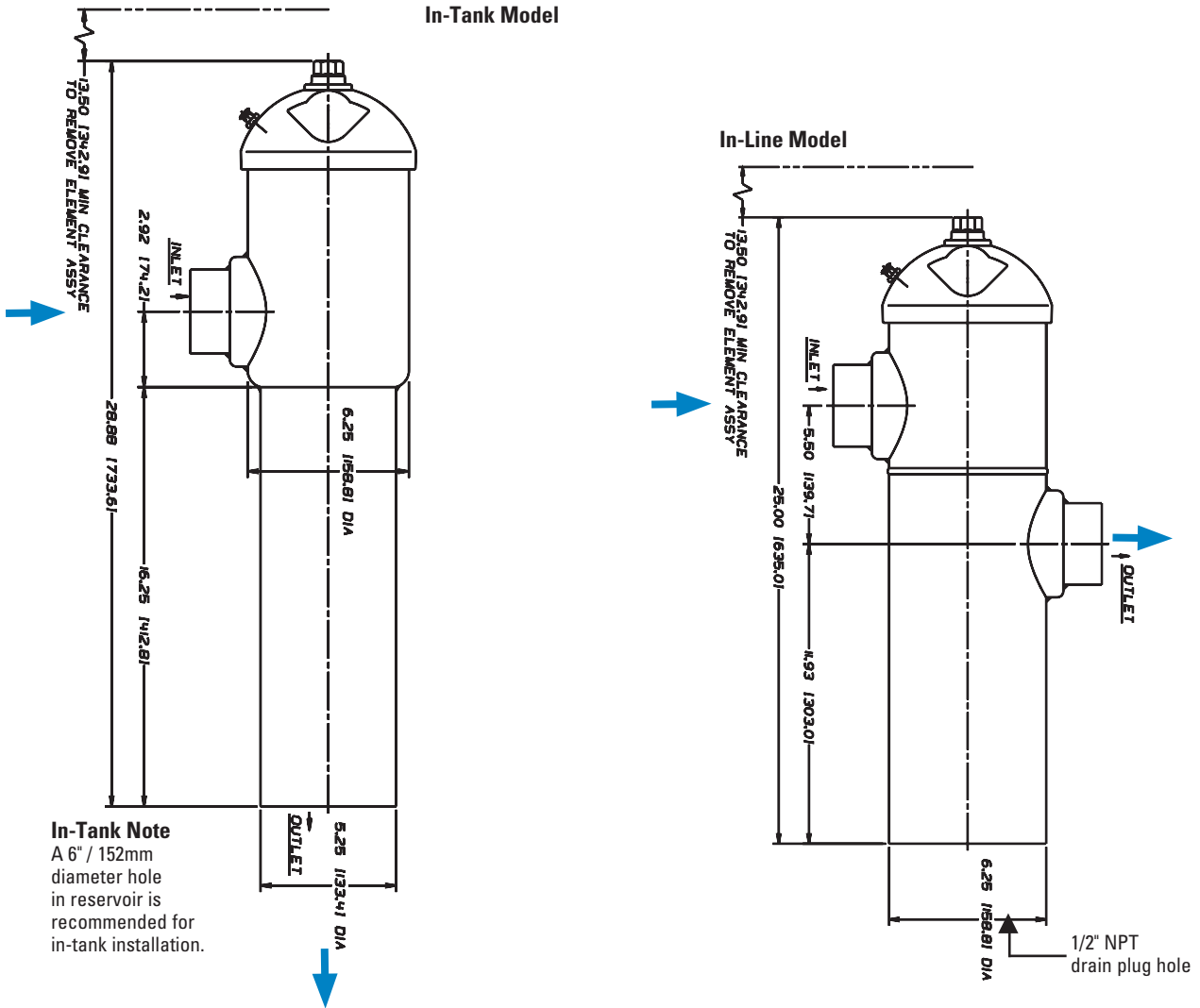

HEAD - TOP VIEW

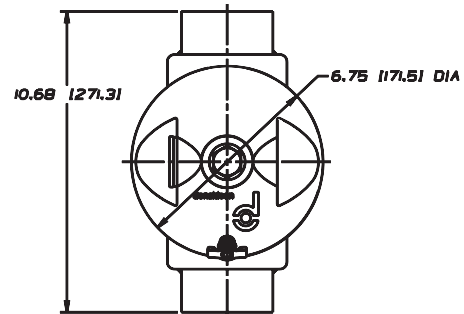
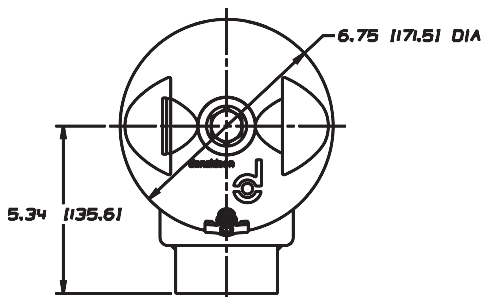



HDK06

Max Flow: 150 gpm (568 lpm)



HDK06 Components

Filter Choices

Media Type	$\beta_{x(c)} = 2$	$\beta_{x(c)} = 1000$	Length		Part No.
	Rating based on ISO 16889		in	mm	
Synteq Synthetic		<4 μm	16.00	406	P161016
		6 μm	16.00	406	P165628
		11 μm	16.00	406	P176221
		22 μm	16.00	406	P161571
		23 μm	16.00	406	P164699
		50 μm	16.00	406	P166597
Wire Mesh	150 μm		11.6	294	P160700

Filter Notes

Standard HDK06 replacement filters have nitrile seals, which are appropriate for most applications involving petroleum oil. Filters with seals made of fluorocarbon are required when using diester, phosphate ester fluids, water glycol, water/oil emulsions, and HWCF (high water content fluids) over 150°F.

HDK06 filters are inside to outside reverse flow 4.39" (112mm) OD.

Refer to the table in the Technical Reference Guide for fluid compatibility with our filter media.

Assembly Choices

Style	Part No.	Port Size	Bypass Rating	Indicator	Includes Filter Cartridge
In-Tank	K060173	2½" NPT	25 psi / 172.5 kPa	Visual	P176221
In-Line	K060160	2½" NPT	25 psi / 172.5 kPa	Visual	P176221

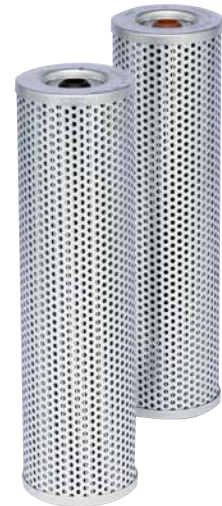

Performance Data

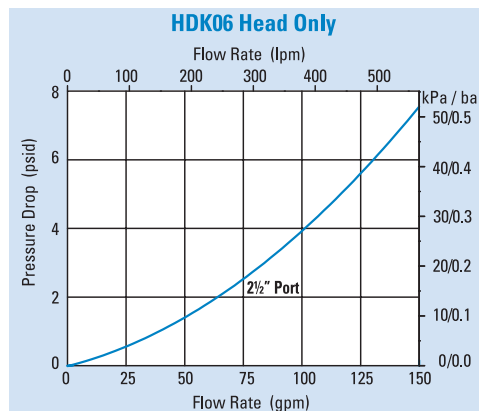
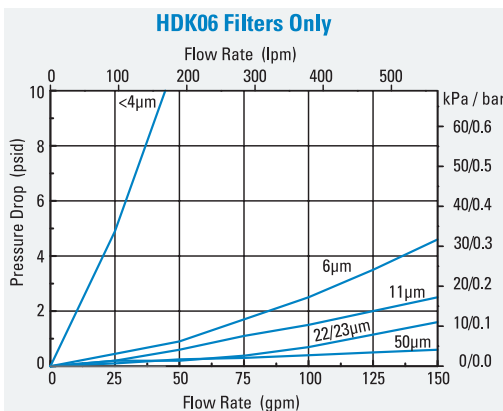

HDK06 Service Parts

SERVICE PARTS NOTE:

Some service parts may not be stocked. Please contact your Donaldson sales representative for lead time details.

**Optional Tee Handle
for Easier Servicing**

The first step in changing the HDK06 cartridge is loosening the top nut with a wrench. Our optional tee handle makes this job easier. The P160135 kit, comprised of the handle, an O-Ring, and a clip ring, replaces the entire top nut assembly.

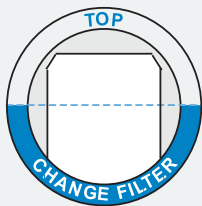
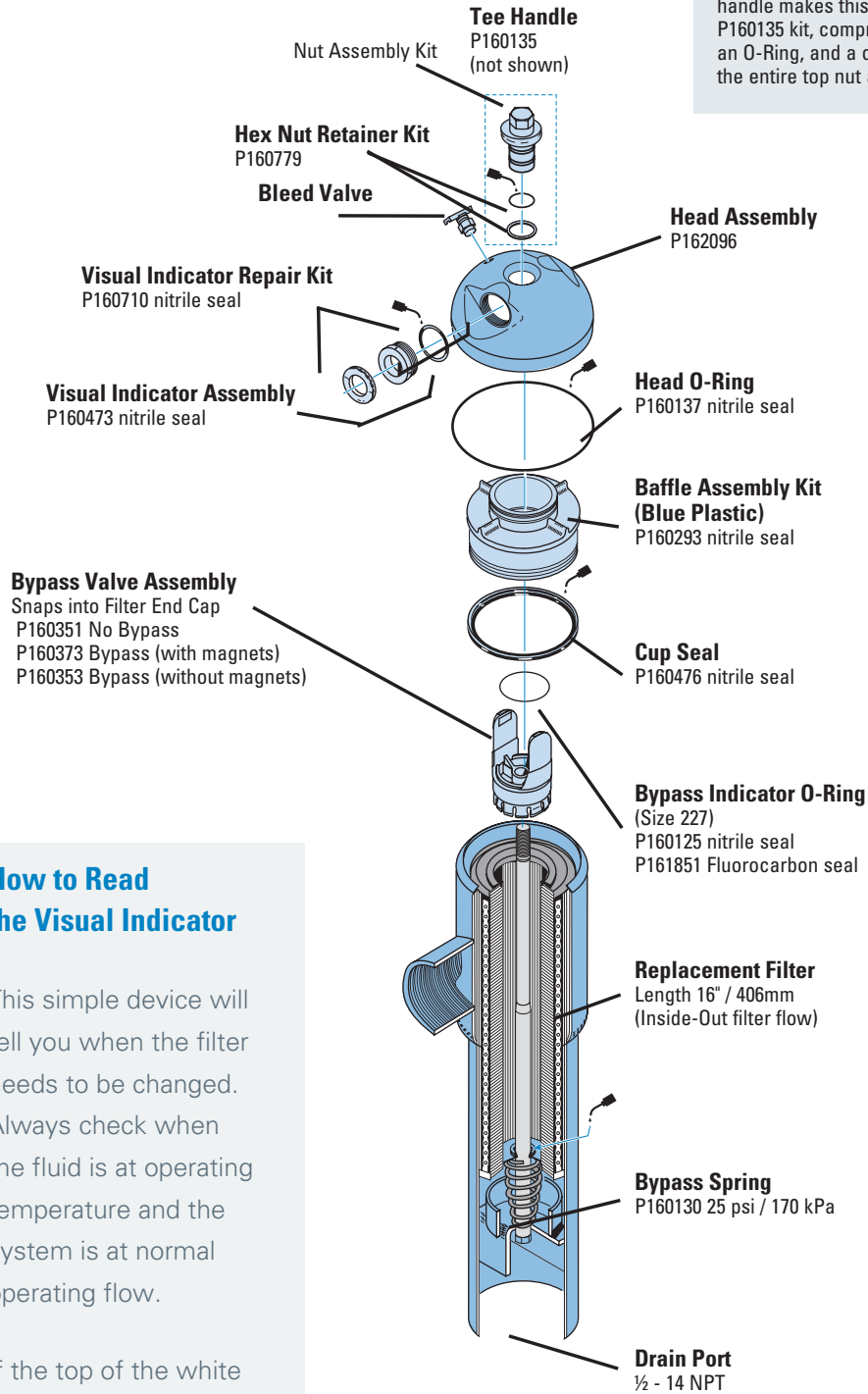

Filter OK

How to Read the Visual Indicator

This simple device will tell you when the filter needs to be changed. Always check when the fluid is at operating temperature and the system is at normal operating flow.

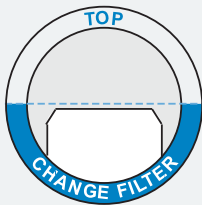

Filter Needs Service

If the top of the white panel is below the lower half of the window, the filter needs servicing.